

Pozinkované tvarovky RA

Výrobce:	Assotherm, s.r.l.
Aplikace:	určené pro rozvody vody, rozvody topení, rozvody stlačeného vzduchu podle standardů ISO-49 a EN 10242
Certifikace:	CSTB, DVGW, WRAS
Materiál:	temperovaná litina EN-GJMB-350-10, s mechanickými vlastnostmi dle EN1562
Galvanizace:	žárové zinkování (ochranná vrstva zinku 70 - 80 µm), ochrana zinkového povrchu podle EN 10242 čl. 5.2
Závity:	vnitřní - kuželové (Rp), dle ISO 7-1 vnější - kuželové (R) montážní závity (např. matice šroubení) - trubkové (G) dle ISO 228
Pracovní tlak:	25 bar
Pracovní teplota:	-20/+300 °C

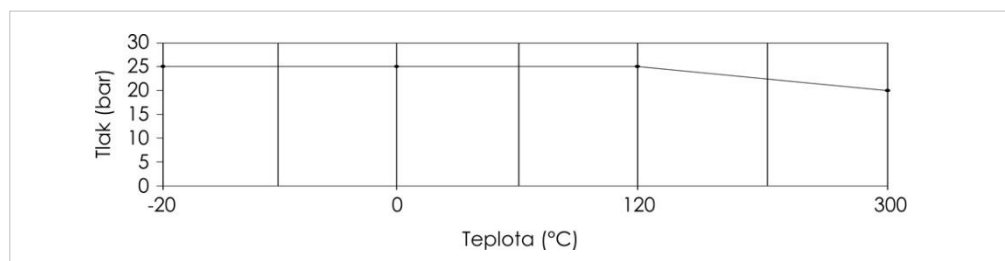

Graf závislosti teploty a tlaku:



Technická data jednotlivých provedení:

Kolena 90° RA090

Obj. č.	Závity	a (mm)
RA090-14	1/4"	21
RA090-38	3/8"	25
RA090-12	1/2"	28
RA090-34	3/4"	33
RA090-10	1"	38
RA090-54	1 1/4"	45
RA090-15	1 1/2"	50
RA090-20	2"	58
RA090-25	2 1/2"	69
RA090-30	3"	78
RA090-40	4"	96
RA090-50	5"	115
RA090-60	6"	131

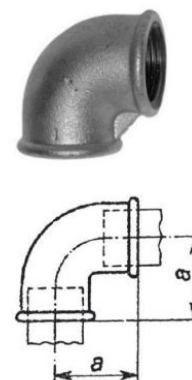

Kolena 90° RA092

Obj. č.	Závit	a (mm)	b (mm)
RA092-38	3/8"	25	32
RA092-12	1/2"	28	37
RA092-34	3/4"	33	43
RA092-10	1"	38	52
RA092-54	1 1/4"	45	60
RA092-15	1 1/2"	50	65
RA092-20	2"	58	74
RA092-25	2 1/2"	69	88
RA092-30	3"	78	98
RA092-40	4"	96	118

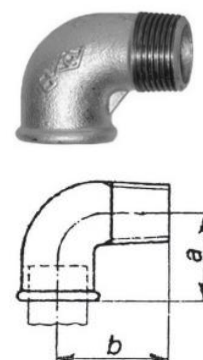

Pozinkované tvarovky RA

Kolena 90° redukovaná RA091

Obj. č.	Závity	a (mm)	b (mm)
RA091-3812	3/8" - 1/2"	26	26
RA091-3834	3/8" - 3/4"	28	28
RA091-1234	1/2" - 3/4"	30	31
RA091-1210	1/2" - 1"	32	34
RA091-3410	3/4" - 1"	35	36
RA091-1254	1 1/2" - 1 1/4"	35	36
RA091-3454	3/4" - 1 1/4"	36	41
RA091-1054	1" - 1 1/4"	40	42
RA091-1015	1" - 1 1/2"	42	46
RA091-5415	1 1/4" - 1 1/2"	46	48
RA091-1020	1" - 2"	44	52
RA091-5420	1 1/4" - 2"	50	55
RA091-1520	1 1/2" - 2"	52	55
RA091-2025	2" - 2 1/2"	61	66
RA091-2530	2 1/2" - 3"	72	75

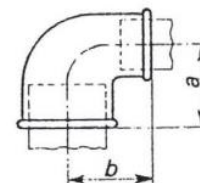

X-kusy RA180

Obj. č.	Závít	a (mm)
RA180-38	3/8"	25
RA180-12	1/2"	28
RA180-34	3/4"	33
RA180-10	1"	38
RA180-54	1 1/4"	45
RA180-15	1 1/2"	50
RA180-20	2"	58
RA180-25	2 1/2"	69
RA180-30	3"	78
RA180-40	4"	96

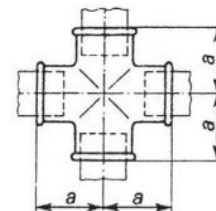

T-kusy RA130

Obj. č.	Závity	a (mm)
RA130-38	3/8"	25
RA130-12	1/2"	28
RA130-34	3/4"	33
RA130-10	1"	38
RA130-54	1 1/4"	45
RA130-15	1 1/2"	50
RA130-20	2"	58
RA130-25	2 1/2"	69
RA130-30	3"	78
RA130-40	4"	96
RA130-50	5"	115
RA130-60	6"	131

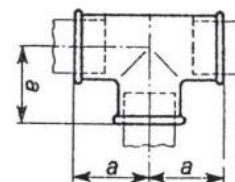

Pozinkované tvarovky RA

T-kusy redukované RA131

Obj. č.	Závity	a (mm)	b (mm)	c (mm)
RA131-123812	1/2" - 3/8" - 1/2"	30	28	30
RA131-123412	1/2" - 3/4" - 1/2"	32	36	32
RA131-341212	3/4" - 1/2" - 1/2"	33	35	30
RA131-341234	3/4" - 1/2" - 3/4"	33	35	33
RA131-343412	3/4" - 3/4" - 1/2"	36	36	32
RA131-341034	3/4" - 1" - 3/4"	38	39	38
RA131-101212	1" - 1/2" - 1/2"	35	36	30
RA131-101234	1" - 1/2" - 3/4"	35	36	33
RA131-101210	1" - 1/2" - 1"	35	36	35
RA131-103412	1" - 3/4" - 1/2"	38	39	33
RA131-103434	1" - 3/4" - 3/4"	38	39	35
RA131-103410	1" - 3/4" - 1"	38	39	38
RA131-101012	1" - 1" - 1/2"	40	40	39
RA131-101034	1" - 1" - 3/4"	40	40	39
RA131-541210	1 1/4" - 1/2" - 1"	37	41	37
RA131-541254	1 1/4" - 1/2" - 1 1/4"	37	41	37
RA131-543434	1 1/4" - 3/4" - 3/4"	39	44	36
RA131-543410	1 1/4" - 3/4" - 1"	39	44	38
RA131-543454	1 1/4" - 3/4" - 1 1/4"	39	44	39
RA131-541010	1 1/4" - 1" - 1"	43	45	40
RA131-541054	1 1/4" - 1" - 1 1/4"	43	45	43
RA131-545412	1 1/4" - 1 1/4" - 1/2"	48	48	40
RA131-545434	1 1/4" - 1 1/4" - 3/4"	48	48	44
RA131-545410	1 1/4" - 1 1/4" - 1"	48	48	45
RA131-151254	1 1/2" - 1/2" - 1 1/4"	38	43	37
RA131-151215	1 1/2" - 1/2" - 1 1/2"	38	43	38
RA131-153415	1 1/2" - 3/4" - 1 1/2"	40	47	40
RA131-151010	1 1/2" - 1" - 1"	45	49	41
RA131-151054	1 1/2" - 1" - 1 1/4"	45	49	43
RA131-151015	1 1/2" - 1" - 1 1/2"	45	49	45
RA131-155454	1 1/2" - 1 1/4" - 1 1/4"	49	50	48
RA131-155415	1 1/2" - 1 1/4" - 1 1/2"	49	50	49
RA131-151512	1 1/2" - 1 1/2" - 1/2"	53	53	45
RA131-151534	1 1/2" - 1 1/2" - 3/4"	53	53	47
RA131-151510	1 1/2" - 1 1/2" - 1"	53	53	49
RA131-151554	1 1/2" - 1 1/2" - 1 1/4"	53	53	51
RA131-201215	2" - 1/2" - 1 1/2"	43	51	45
RA131-201220	2" - 1/2" - 2"	43	51	43
RA131-203420	2" - 3/4" - 2"	65	65	53
RA131-201020	2" - 1" - 2"	61	55	61
RA131-205420	2" - 1 1/4" - 2"	65	54	65
RA131-201515	2" - 1 1/2" - 1 1/2"	55	58	54
RA131-201520	2" - 1 1/2" - 2"	55	58	55
RA131-202012	2" - 2" - 1/2"	61	61	51
RA131-202034	2" - 2" - 3/4"	61	61	53
RA131-202010	2" - 2" - 1"	61	61	55
RA131-202015	2" - 2" - 1 1/2"	61	61	58
RA131-251025	2 1/2" - 1" - 2 1/2"	49	63	49
RA131-255425	2 1/2" - 1 1/4" - 2 1/2"	55	65	55
RA131-251525	2 1/2" - 1 1/2" - 2 1/2"	58	66	58
RA131-252025	2 1/2" - 2" - 2 1/2"	64	69	64
RA131-301030	3" - 1" - 3"	54	70	54
RA131-305430	3" - 1 1/4" - 3"	56	72	56
RA131-301530	3" - 1 1/2" - 3"	60	73	60
RA131-302030	3" - 2" - 3"	66	76	66
RA131-302530	3" - 2 1/2" - 3"	74	79	74
RA131-402040	4" - 2" - 4"	73	89	73
RA131-402540	4" - 2 1/2" - 4"	80	92	80
RA131-403040	4" - 3" - 4"	88	96	88

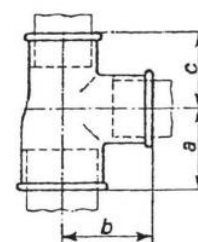

Pozinkované tvarovky RA

Oblouky 90° RA001

Obj. č.	Závit	a (mm)	b (mm)
RA001-12	1/2"	55	48
RA001-34	3/4"	69	60
RA001-10	1"	85	75
RA001-54	1 1/4"	105	95
RA001-15	1 1/2"	116	106
RA001-20	2"	140	130
RA001-25	2 1/2"	176	165
RA001-30	3"	205	190
RA001-40	4"	260	245

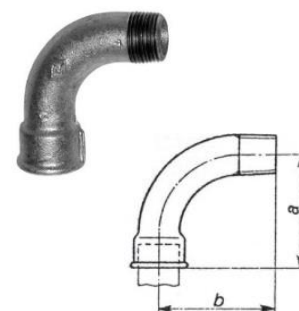

Oblouky 90° RA002

Obj. č.	Závit	a (mm)	z (mm)
RA002-38	3/8"	48	38
RA002-12	1/2"	55	42
RA002-34	3/4"	69	54
RA002-10	1"	85	68
RA002-54	1 1/4"	105	86
RA002-15	1 1/2"	116	97
RA002-20	2"	140	116



Oblouky 45° RA041

Obj. č.	Závit	a (mm)
RA041-12	1/2"	36
RA041-34	3/4"	43
RA041-10	1"	51
RA041-54	1 1/4"	64
RA041-15	1 1/2"	68
RA041-20	2"	81
RA041-25	2 1/2"	99
RA041-30	3"	113
RA041-40	4"	142

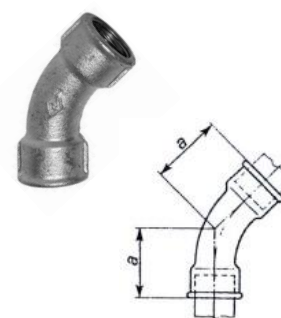

Oblouky 45° RA040

Obj. č.	Závit	a (mm)	b (mm)
RA040-12	1/2"	36	30
RA040-34	3/4"	43	36
RA040-10	1"	51	42
RA040-54	1 1/4"	64	54
RA040-15	1 1/2"	68	58
RA040-20	2"	81	70
RA040-25	2 1/2"	99	86
RA040-30	3"	113	100
RA040-40	4"	142	125



Oblouky přemosťovací RA085

Obj. č.	Závit	a (mm)
RA085-12	1/2" - 1/2"	90
RA085-34	3/4" - 3/4"	106
RA085-10	1" - 1"	140

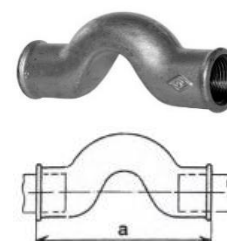

Pozinkované tvarovky RA

Redukce RA241

Obj. č.	Závity	a (mm)
RA241-1412	1/4" - 1/2"	24
RA241-3812	1/2" - 3/8"	24
RA241-1434	1/4" - 3/4"	26
RA241-3834	3/4" - 3/8"	26
RA241-1234	3/4" - 1/2"	26
RA241-3810	1" - 3/8"	29
RA241-1210	1" - 1/2"	29
RA241-3410	1" - 3/4"	29
RA241-1254	1 1/4" - 1/2"	31
RA241-3454	1 1/4" - 3/4"	31
RA241-1054	1 1/4" - 1"	31
RA241-1215	1 1/2" - 1/2"	31
RA241-3415	1 1/2" - 3/4"	31
RA241-1015	1 1/2" - 1"	31
RA241-5415	1 1/2" - 1 1/4"	31
RA241-1220	2" - 1/2"	35
RA241-3420	2" - 3/4"	35
RA241-1020	2" - 1"	35
RA241-5420	2" - 1 1/4"	35
RA241-1520	2" - 1 1/2"	35
RA241-1025	2 1/2" - 1"	40
RA241-5425	2 1/2" - 1 1/4"	40
RA241-1525	2 1/2" - 1 1/2"	40
RA241-2025	2 1/2" - 2"	40
RA241-1030	3" - 1"	44
RA241-5430	3" - 1 1/4"	44
RA241-1530	3" - 1 1/2"	44
RA241-2030	3" - 2"	44
RA241-2530	3" - 2 1/2"	44
RA241-2040	4" - 2"	51
RA241-2540	4" - 2 1/2"	51
RA241-3040	4" - 3"	51
RA241-4050	5" - 4"	61
RA241-4060	6" - 4"	65

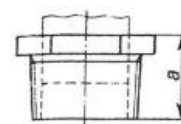

Redukce RA246

Obj. č.	Závity	a (mm)
RA246-3812	1/2" - 3/8"	43
RA246-1234	3/4" - 1/2"	48
RA246-1210	1" - 1/2"	55
RA246-3410	1" - 3/4"	57
RA246-3454	1 1/4" - 3/4"	60
RA246-1054	1 1/4" - 1"	62
RA246-1015	1 1/2" - 1"	63
RA246-5415	1 1/2" - 1 1/4"	63
RA246-1020	2" - 1"	71
RA246-5420	2" - 1 1/4"	70
RA246-1520	2" - 1 1/2"	70
RA246-2025	2 1/2" - 2"	70
RA246-2530	3" - 2 1/2"	80



Pozinkované tvarovky RA

Hrdla RA270

Obj. č.	Závit	a (mm)
RA270-38	3/8"	30
RA270-12	1/2"	36
RA270-34	3/4"	39
RA270-10	1"	45
RA270-54	1 1/4"	50
RA270-15	1 1/2"	55
RA270-20	2"	65
RA270-25	2 1/2"	74
RA270-30	3"	80
RA270-40	4"	94
RA270-50	5"	109
RA270-60	6"	120

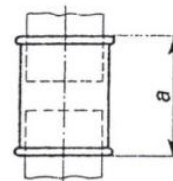

Hrdla redukovaná RA240

Obj. č.	Závit	a (mm)
RA240-3812	1/2" - 3/8"	36
RA240-3834	3/4" - 3/8"	39
RA240-1234	3/4" - 1/2"	39
RA240-1210	1" - 1/2"	45
RA240-3410	1" - 3/4"	45
RA240-1254	1 1/4" - 1/2"	50
RA240-3454	1 1/4" - 3/4"	50
RA240-1054	1 1/4" - 1"	50
RA240-3415	1 1/2" - 3/4"	55
RA240-1015	1 1/2" - 1"	55
RA240-5415	1 1/2" - 1 1/4"	55
RA240-1220	2" - 1/2"	65
RA240-3420	2" - 3/4"	65
RA240-1020	2" - 1"	65
RA240-5420	2" - 1 1/4"	74
RA240-1520	2" - 1 1/2"	74
RA240-1025	2 1/2" - 1"	74
RA240-5425	2 1/2" - 1 1/4"	74
RA240-1525	2 1/2" - 1 1/2"	74
RA240-2025	2 1/2" - 2"	74
RA240-2030	3" - 2"	80
RA240-2530	3" - 2 1/2"	80
RA240-2040	4" - 2"	94
RA240-2540	4" - 2 1/2"	94
RA240-3040	4" - 3"	94

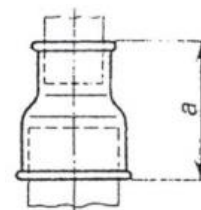

Vsuvky RA280

Obj. č.	Závit	a (mm)
RA280-38	3/8"	38
RA280-12	1/2"	44
RA280-34	3/4"	47
RA280-10	1"	53
RA280-54	1 1/4"	57
RA280-15	1 1/2"	60
RA280-20	2"	68
RA280-25	2 1/2"	75
RA280-30	3"	83
RA280-40	4"	95
RA280-50	5"	100
RA280-60	6"	119

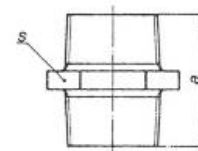

Pozinkované tvarovky RA

Vsuvky redukované RA245

Obj. č.	Závity	a (mm)	S (mm)
RA245-1438	3/8" - 1/4"	36	22
RA245-1412	1/2" - 1/4"	38	22
RA245-3812	1/2" - 3/8"	38	22
RA245-3834	3/4" - 3/8"	47	30
RA245-1234	3/4" - 1/2"	47	30
RA245-1210	1" - 1/2"	53	36
RA245-3410	1" - 3/4"	53	36
RA245-1254	1 1/4" - 1/2"	57	46
RA245-3454	1 1/4" - 3/4"	57	46
RA245-1054	1 1/4" - 1"	57	46
RA245-3415	1 1/2" - 3/4"	57	50
RA245-1015	1 1/2" - 1"	57	50
RA245-5415	1 1/2" - 1 1/4"	59	50
RA245-1020	2" - 1"	66	64
RA245-5420	2" - 1 1/4"	65	65
RA245-1520	2" - 1 1/2"	65	65
RA245-1525	2 1/2" - 1 1/2"	75	65
RA245-2025	2 1/2" - 2"	75	65
RA245-2030	3" - 2"	83	95
RA245-2530	3" - 2 1/2"	83	95
RA245-2540	4" - 2 1/2"	87	124
RA245-3040	4" - 3"	90	124

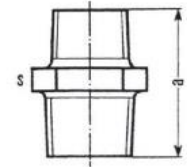

Záslepky RA290

Obj. č.	Závit	c (mm)	S (mm)
RA290-38	3/8"	24	12
RA290-12	1/2"	29	12
RA290-34	3/4"	35	18
RA290-10	1"	36	23
RA290-54	1 1/4"	39	23
RA290-15	1 1/2"	41	28
RA290-20	2"	48	33
RA290-25	2 1/2"	54	32
RA290-30	3"	60	42
RA290-40	4"	70	41

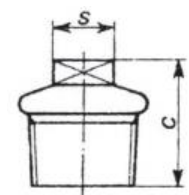

Záslepky RA300

Obj. č.	Závit	a (mm)
RA300-38	3/8"	17
RA300-12	1/2"	19
RA300-34	3/4"	22
RA300-10	1"	24
RA300-54	1 1/4"	27
RA300-15	1 1/2"	27
RA300-20	2"	32
RA300-25	2 1/2"	35
RA300-30	3"	38
RA300-40	4"	45

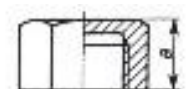

Pozinkované tvarovky RA

Kolena 45° RA120

Obj. č.	Závit	a (mm)
RA120-12	1/2"	22
RA120-34	3/4"	25
RA120-10	1"	28
RA120-54	1 1/4"	33
RA120-15	1 1/2"	36
RA120-20	2"	43



Kolena 45° RA121

Obj. č.	Závit	a (mm)	b (mm)
RA121-12	1/2"	22	28
RA121-34	3/4"	25	32
RA121-10	1"	28	37
RA121-54	1 1/4"	33	43
RA121-15	1 1/2"	36	46
RA121-20	2"	43	55

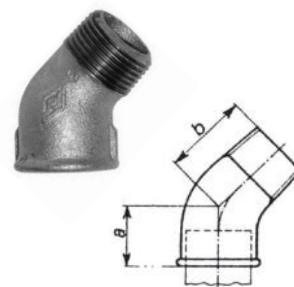

Šroubení RA340

Obj. č.	Závit	a (mm)
RA340-38	3/8"	45
RA340-12	1/2"	48
RA340-34	3/4"	52
RA340-10	1"	58
RA340-54	1 1/4"	65
RA340-15	1 1/2"	70
RA340-20	2"	78
RA340-25	2 1/2"	85
RA340-30	3"	95
RA340-40	4"	110

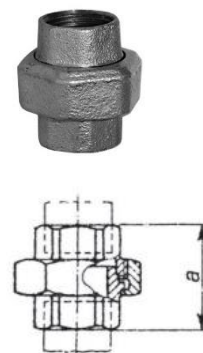

Šroubení RA341

Obj. č.	Závit	b (mm)
RA341-38	3/8"	58
RA341-12	1/2"	66
RA341-34	3/4"	72
RA341-10	1"	80
RA341-54	1 1/4"	90
RA341-15	1 1/2"	95
RA341-20	2"	106
RA341-25	2 1/2"	118
RA341-30	3"	130
RA341-40	4"	145

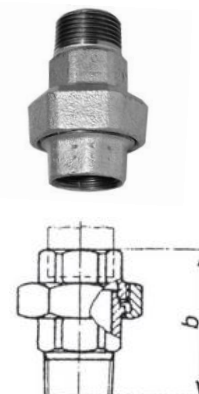

Pozinkované tvarovky RA

Šroubení úhlová RA096

Obj. č.	Závit	a (mm)	c (mm)
RA096-12	1/2"	58	28
RA096-34	3/4"	62	33
RA096-10	1"	72	38
RA096-54	1 1/4"	82	45
RA096-15	1 1/2"	90	50
RA096-20	2"	100	58
RA096-25	2 1/2"	122	70
RA096-30	3"	135	78

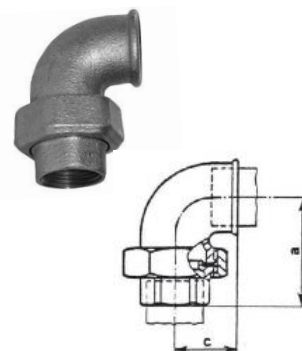

Šroubení úhlová RA098

Obj. č.	Závit	b (mm)	c (mm)
RA098-12	1/2"	76	28
RA098-34	3/4"	82	33
RA098-10	1"	94	38
RA098-54	1 1/4"	107	45
RA098-15	1 1/2"	115	50
RA098-20	2"	128	58
RA098-25	2 1/2"	152	70
RA098-30	3"	168	78

